

Installation Support • Soporte de instalación • Support d'installation

Personal Assistance, Product Specs, & "How-to" Questions:

Asistencia personal, especificaciones del producto y preguntas sobre "cómo hacerlo":  
Aide personnelle, spécifications du produit et questions « pratique-pratiques » :

**1-800-PFAUCET (732-8238)**  
**pfisterfaucets.com/support**

Installation Videos Available  
Videos de instalación a disposición  
Vidéos d'installation disponibles



pfisterfaucets.com/videos



**WARNING / ADVERTENCIA / AVERTISSEMENT**

To reduce the risk of injury or property damage, read all instructions before installing product. Wear safety goggles. Product must be installed in accordance with all state & local plumbing & building codes. Call a professional if you are uncertain about installing this product.

Para disminuir el riesgo de lesiones o daños a la propiedad, lea todas las instrucciones antes de instalar el producto. Utilice gafas de seguridad. El producto deberá instalarse de acuerdo con la normativa de plomería y construcción estatal y local. Llame a un profesional si no está seguro sobre cómo instalar este producto.

Pour réduire le risque de blessures ou de dommages, lire toutes les instructions avant d'installer le produit. Porter des lunettes de sécurité. Le produit doit être installé en conformité avec tous les codes de construction et de plomberie locaux et de l'état. Appelez un professionnel si vous n'êtes pas certain de la façon d'installer ce produit.

**Required Tools**  
Herramientas necesarias  
Outils nécessaires

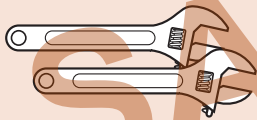

Adjustable Wrenches  
Llaves ajustables  
Clés à mollette



Safety Goggles  
Gafas de seguridad  
Lunettes de sûreté

**Additional Helpful Tools**  
Otras herramientas útiles  
Outils supplémentaires utiles

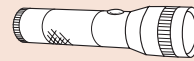

Flashlight  
Linterna  
Lampe De Poche



Cloth  
Paño  
Chiffon

**Parts in the Box**  
Piezas en la caja  
Pièces dans la boîte

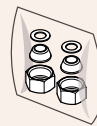
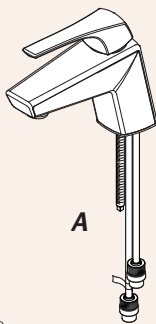

Items shown are not to scale.  
De resultados no están a escala.  
Produits affichés ne sont pas à l'échelle.

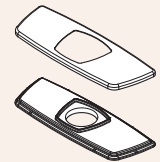

Optional Deck Plate (not included) see page 3.  
Placa de cubierta opcional (no incluido), véase la página 3.  
Plaque de pont en option (non inclus), voir page 3.

**1 Turn Off Water Supply • Cierre el suministro de agua • Couper l'alimentation en eau**



Locate water supply inlets and shut off the water supply valves. These are usually found under the sink or near the water meter. If you are replacing an existing faucet, remove the old faucet from the sink and clean the sink surface thoroughly.

Ubique las entradas del suministro de agua y cierre las válvulas de suministro de agua. Generalmente se encuentran debajo del fregadero o cerca del medidor de agua. Si se trata de un reemplazo de grifo, quite el grifo viejo y limpie completamente la superficie del fregadero.

Recherchez les entrées d'approvisionnement et fermer leurs robinets. Ces robinets se trouvent généralement sous l'évier ou près du compteur d'eau. Si vous remplacez un robinet existant, retirez, le vieux robinet de l'évier et nettoyer soigneusement la surface de ce dernier.

Hot  
Caliente  
Chaud

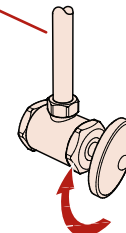

Cold  
Fría  
Froid

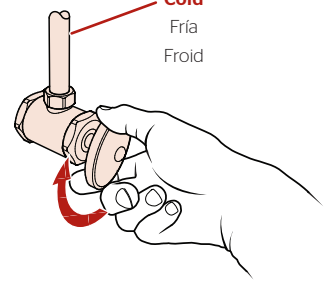

## 2

### Install Faucet **without Deckplate**

Instale el grifo sin la placa de cubierta

Installer le robinet sans le plate-forme

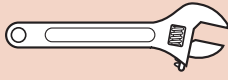

Adjustable Wrench  
Llave ajustable  
Clé réglable

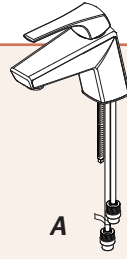

A



B



C



D

### 2A

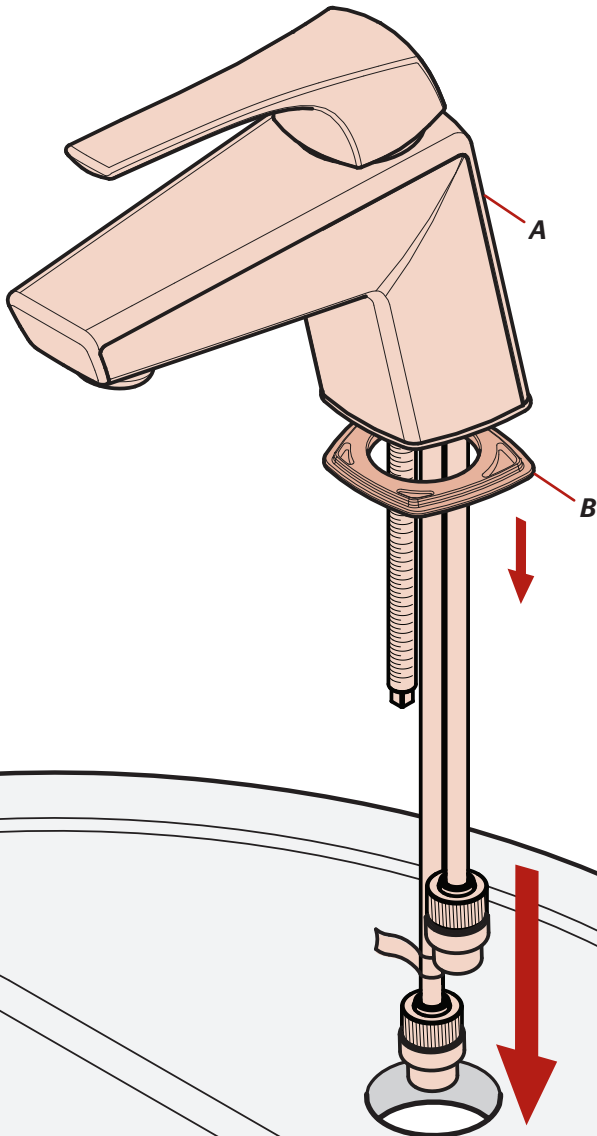

### 2B



**Be sure the spout body (A) is centered & facing forward.  
IMPORTANT: DO NOT OVERTIGHTEN.**

Ceróiese que la estructura del surtidor (A) esté centrada y orientada hacia adelante.  
IMPORTANTE: NO APRIETE EXCESIVAMENTE.

Assurez-vous que le corps du bec (A) est centré et tourné vers l'avant.  
IMPORTANT: NE PAS TROP SERRER.

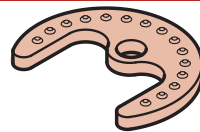

**Bumps face up.**  
Topa cara arriba.  
Cogne récepteur.

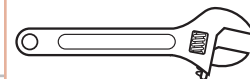
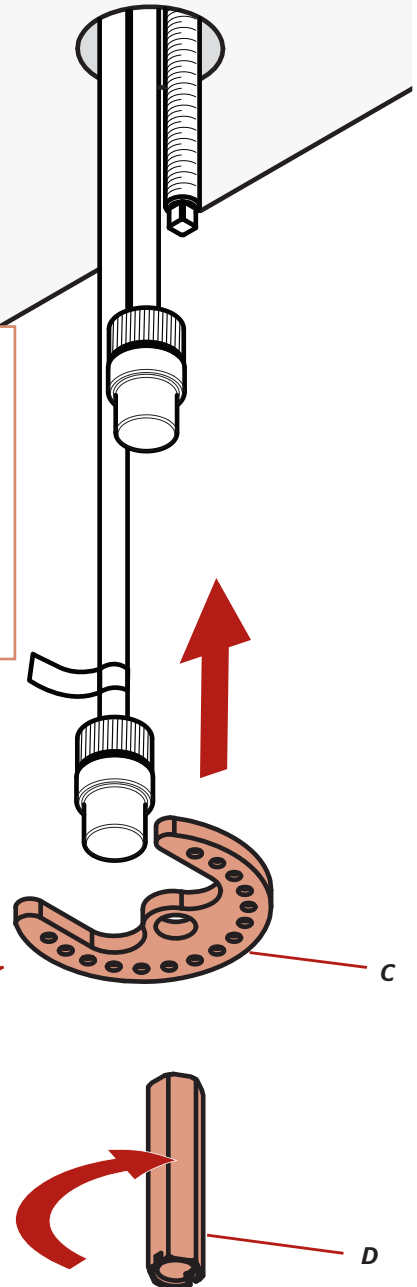

## 2

**OPTION: Install Faucet with Deckplate**

**OPCIÓN: Instale el grifo con la placa de cubierta**

**OPTION: Installer le robinet avec le plate-forme**

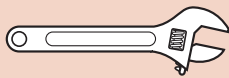

Adjustable Wrench  
Llave ajustable  
Clé réglable

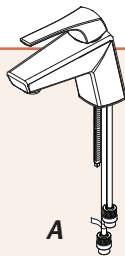

A



E



D

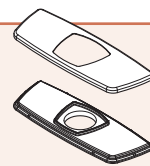

**Optional Deck Plate**  
Placa de cubierta opcional  
Plaque de pont en option

### 2A

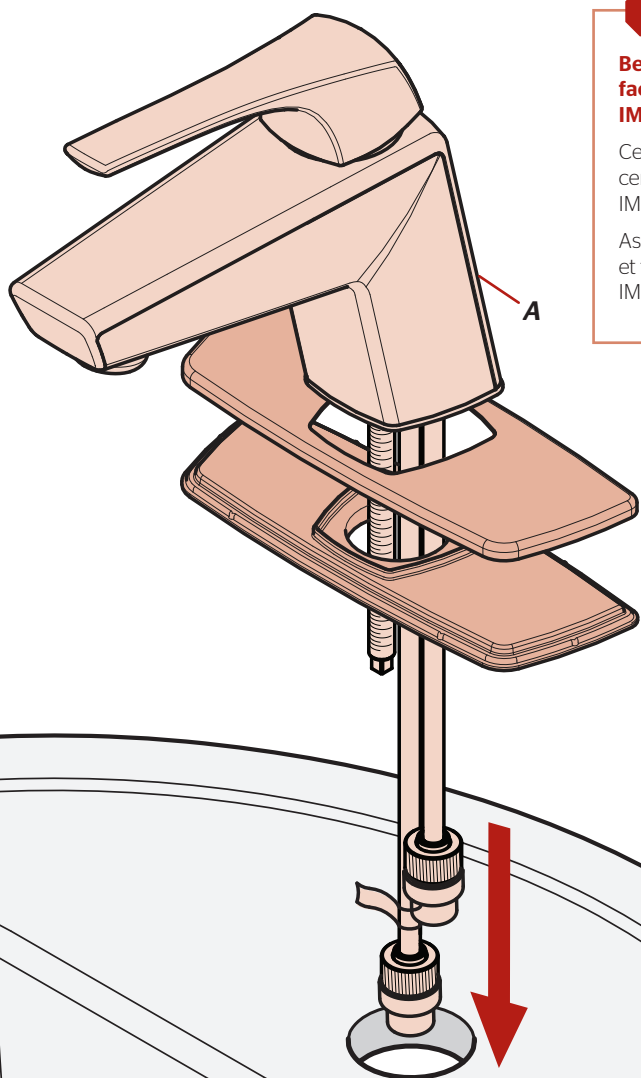

**Be sure the spout body (A) is centered & facing forward.  
IMPORTANT: DO NOT OVERTIGHTEN.**

Cerciórese que la estructura del surtidor (A) esté centrada y orientada hacia adelante.  
IMPORTANTE: NO APRIETE EXCESIVAMENTE.

Assurez-vous que le corps du bec (A) est centré et tourné vers l'avant.  
IMPORTANT: NE PAS TROP SERRER.

### 2B

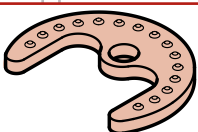
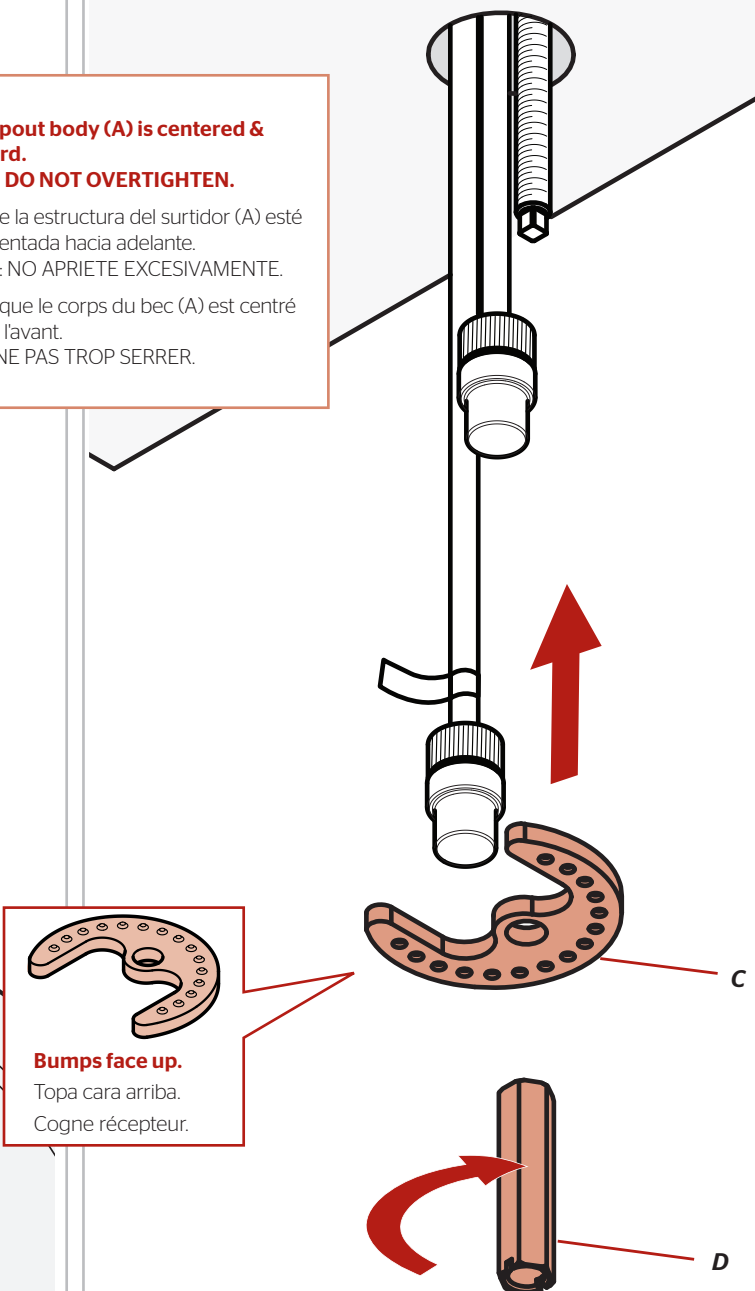

**Bumps face up.**  
Topa cara arriba.  
Cogne récepteur.

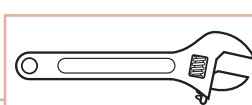

### 3 Connect Water Supply Lines Conecte las tuberías de suministro de agua Raccorder les conduites d'alimentation en eau

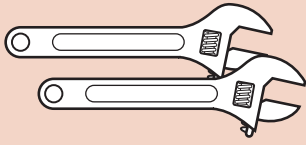

Adjustable Wrenches  
Llaves ajustables  
Clés à mollette



E

**!** Water Supply Lines not included. Please consult manufacturer and/or its instructions for the correct method of installation of supply lines & fittings. **IMPORTANT: Incorrect application of supply lines and fittings may result in the failure or leak of the supply lines and fitting.**

Las tuberías de suministro de agua no están incluidas. Consulte por favor el fabricante y/o sus instrucciones para el método correcto de instalación de líneas de suministro y de guarniciones.

**IMPORTANTE:** El uso incorrecto de líneas de suministro y de guarniciones puede dar lugar a la falta o al escape de las líneas de suministro y de la guarnición.

Les tuyaux d'arrivée d'eau ne sont pas fournis. Veuillez consulter le fabricant et/ou ses instructions pour la méthode correcte d'installation des conduites d'alimentation en eau et des accessoires.

**IMPORTANT:** Mauvaise application des lignes d'alimentation et accessoires peut entraîner la défaillance ou la fuite.

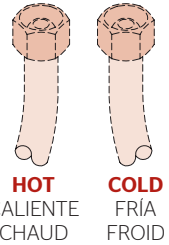

**HOT**  
CALIENTE  
CHAUD

**COLD**  
FRÍA  
FROID

**3A** **x2**  
**Hot & Cold**  
Caliente y fría  
Chaud et froid

**x2**  
**Hot & Cold**  
Caliente y fría  
Chaud et froid

**3B** **x2**  
**Hot & Cold**  
Caliente y fría  
Chaud et froid

**Package Only**  
Empaquetado solamente  
Empaquetage seulement

**Firmly hand tighten**  
Firmemente apriete a mano  
Main serrez **x2**

**3C**

**!** **Separate tubes gently and slightly for clearance.**  
Tubos separados y ligeramente suavemente para su despacho.  
Tubes séparés doucement et légèrement pour le dédouanement.

**COLD**  
FRÍA  
FROID

**Water supply line**  
Línea de suministro del agua  
Ligne d'approvisionnement en eau

**HOT**  
CALIENTE  
CHAUD

**x2**  
**Hot & Cold**  
Caliente y fría  
Chaud et froid

# 4 Prepare & Install Push & Seal™ Drain

## Prepare y instale cuerpo de drenaje Push & Seal™

### Préparez & installez le corps de drainage Push & Seal™

No Tools Required for This Step  
 No se necesitan herramientas para este paso  
 Pas d'outil nécessaire pour cette étape

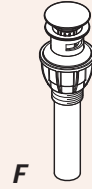

#### 4A Disassemble Pop-Up

##### Desensamble el cuerpo de drenaje

##### Démontez le corps de drainage

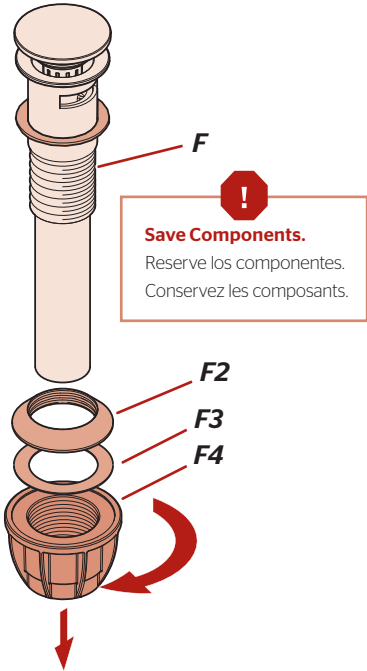

**Save Components.**  
 Reserve los componentes.  
 Conservez les composants.

#### 4B

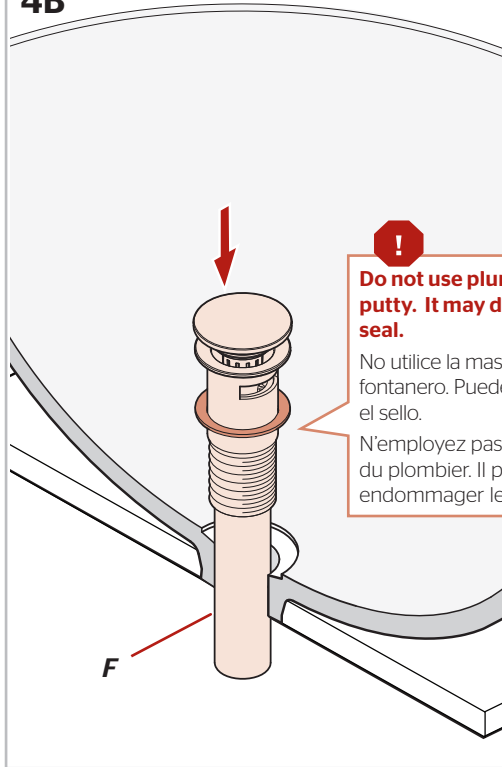

**Do not use plumber's putty. It may damage seal.**  
 No utilice la masilla del fontanero. Puede dañar el sello.  
 N'employez pas le mastic du plombier. Il peut endommager le joint.

#### 4C

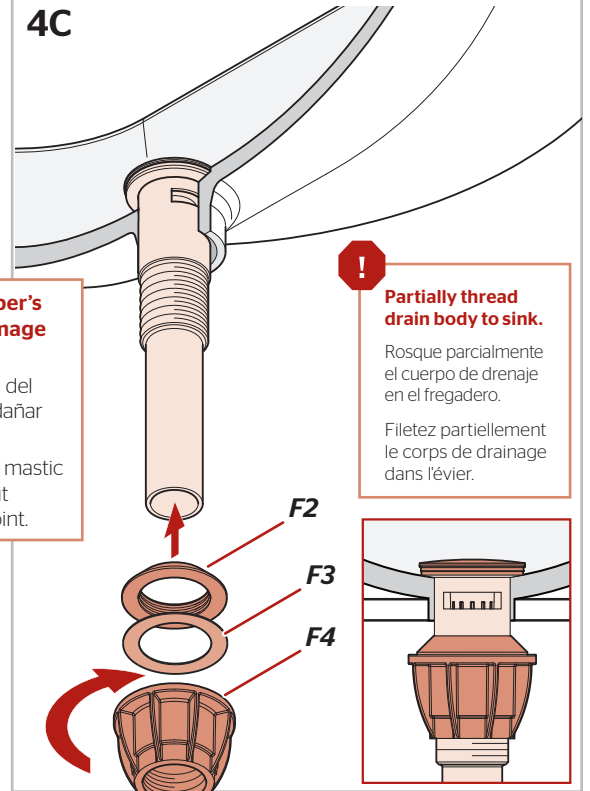

**Partially thread drain body to sink.**  
 Rosque parcialmente el cuerpo de drenaje en el fregadero.  
 Filetez partiellement le corps de drainage dans l'évier.

#### 4D

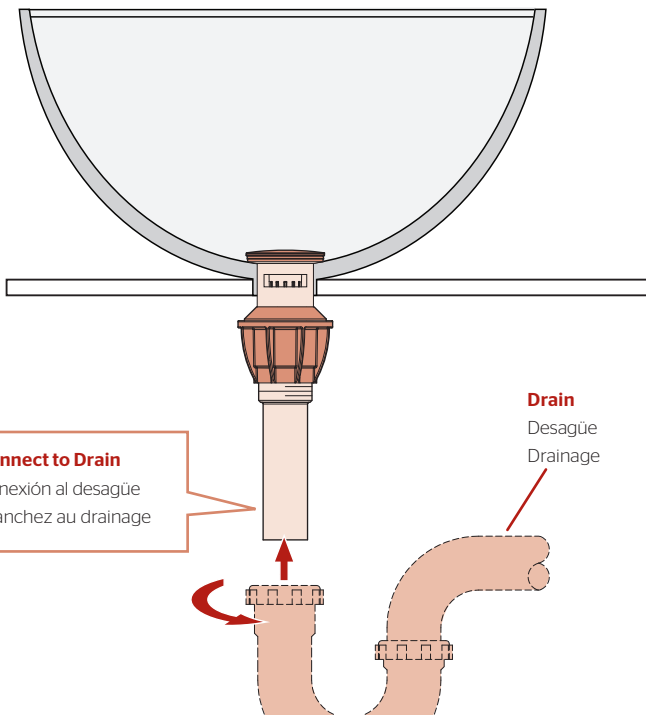

**Connect to Drain**  
 Conexión al desagüe  
 Branchez au drainage

#### 4E

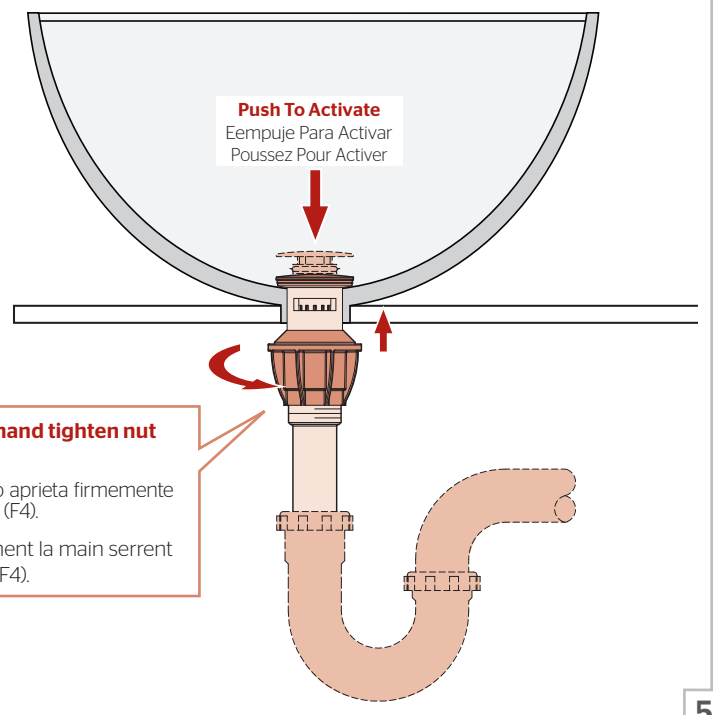

**Push To Activate**  
 Empuje Para Activar  
 Poussez Pour Activer

**Firmly hand tighten nut (F4).**  
 La mano aprieta firmemente la tuerca (F4).  
 Fermentement la main serrent l'écrou (F4).

## 5 Remove and Set Limit Stop

Retire y Ajuste del Tope del Límite

Retirer et mettre de Stop Limit

5A

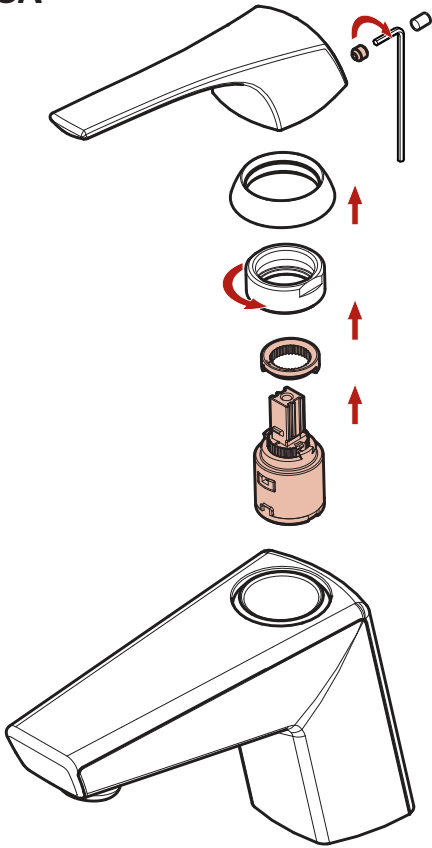

5B

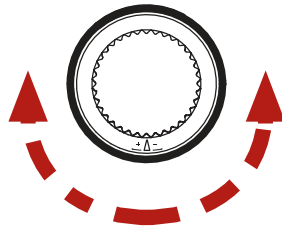

**Rotate to Set to Desired Max Temperature**

Gira por ajuste la Temperatura Máxima Deseada

Tournez pour régler la Température Maximale Désiré

5C

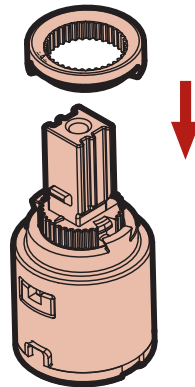

5D

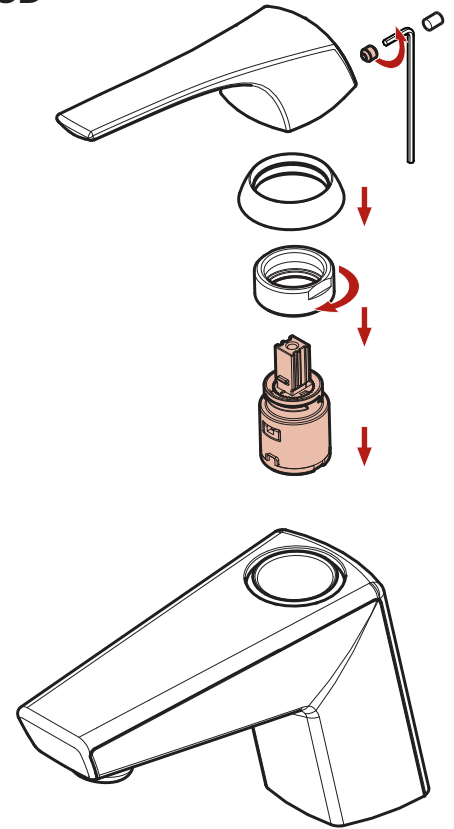

## 6 Turn On Water & Confirm Proper Installation

Active el suministro de agua y confirme que la instalación está adecuadamente efectuada

Ouvrez l'eau et confirmez que l'installation est correcte

6A

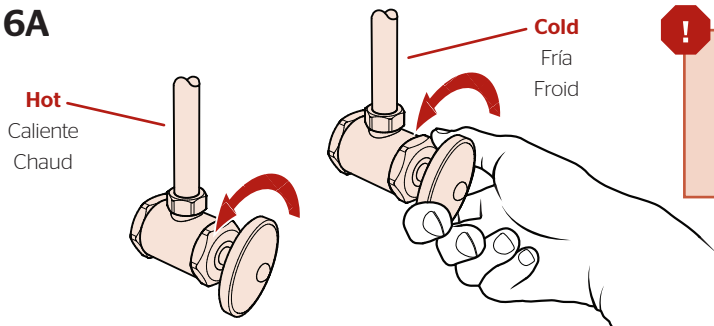

**Check for leaks above and below the sink.**

Revise si hay fugas encima y debajo del fregadero

Assurez-vous qu'il n'y a pas de fuite au dessus ou au dessous du lavabo.

# 7

## Faucet Function

Funciones del grifo

Fonctionnement du robinet

7A

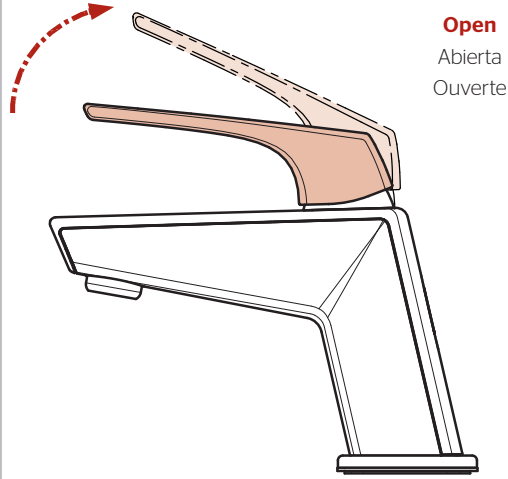

**Open**  
Abierta  
Ouvverte

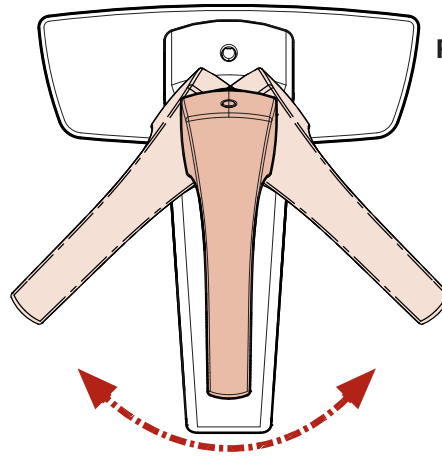

**Hot**  
Caliente  
Chaud

**Faucet Function**  
Funciones del grifo  
Fonctionnement du robinet

**Cold**  
Fría  
Froid

# 8

## Flush the Faucet

Enjuague el grifo

Vidanger l'robinet

8A

**Remove Aerator**  
Retire el aereador  
Retirez l'aérateur

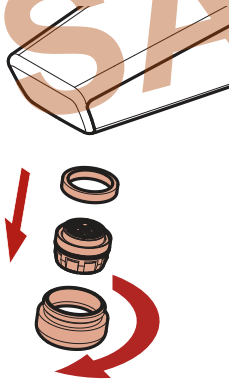

8B

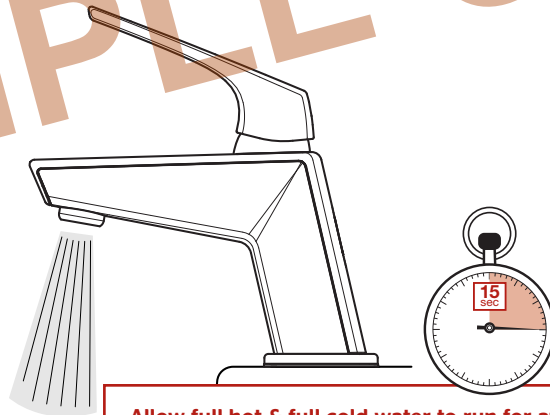

**Allow full hot & full cold water to run for at least 15 seconds each.**

Deje correr el agua caliente y fría durante al menos 15 segundos cada una.

Permettez à l'eau chaude et l'eau froide de couler au moins 15 secondes chacun.

8C

**Reinstall Aerator**  
Reinstale el aereador  
Réinstallez l'aérateur

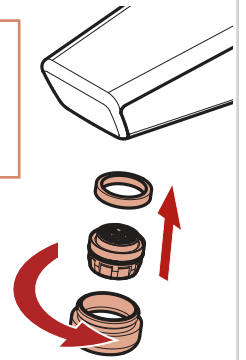

**Hand Tighten**

Apriete con la mano  
Serrez manuellement

**For Additional Installation Help:**

Para la instalación adicionales de ayuda:

Pour les aides supplémentaires à l'installation:

**Pfister**

**1-800-PFAUCET (732-8238)**  
**pfisterfaucets.com**