

Installation Manual

100.4000T - Thermostatic Trim Use With TVH.4101, TVH.4420F, TVH.4301F

BEFORE YOU BEGIN

- You must observe all local plumbing laws and codes.
- Do not install this valve if it does not meet local plumbing codes.
- Shut off the main water supply.

TABLE OF CONTENTS

- Installing The Trim 7

NOTICE TO HOMEOWNER

- We recommend that this product is installed by a qualified professional plumber.
- Please check this product immediately to ensure that it has not been damaged and is complete. Before installation, please make sure this product is the correct model and you have all the parts required for installation and use.
- Please flush the water system to ensure that no metal swarf, solder, and other impurities can enter the product.
- Turn off water supply before commencing work.
- Please read these instructions carefully and retain for future reference.

INSTALLING THE TRIM - TRIM PLATE SIZE AND SHAPE MAY VARY - ILLUSTRATION ONLY

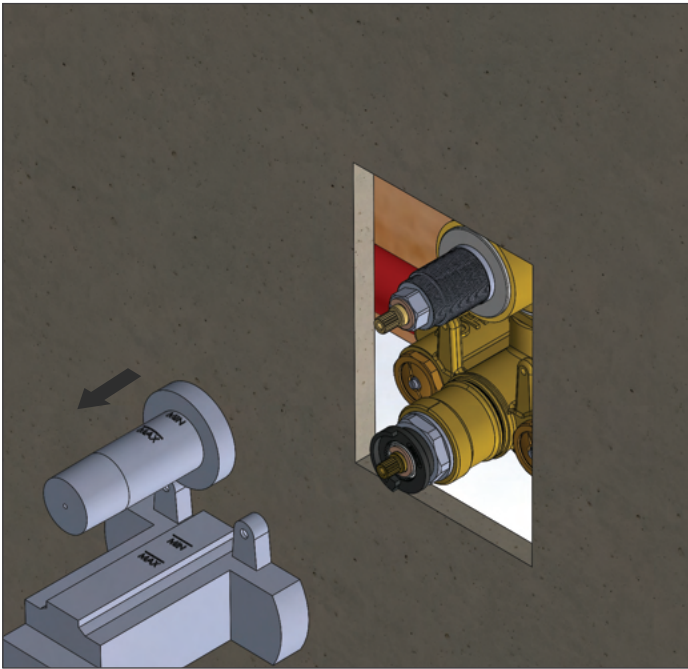

Remove mud guards

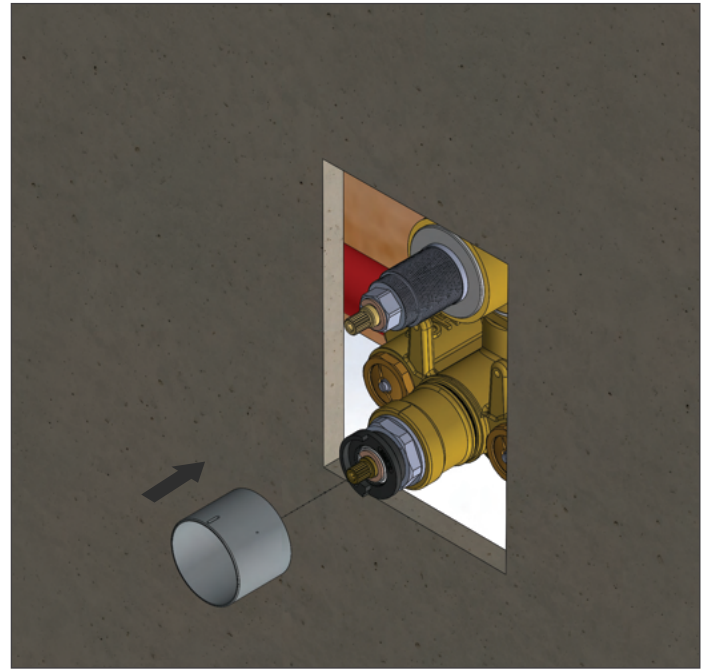

Install 42mm ring

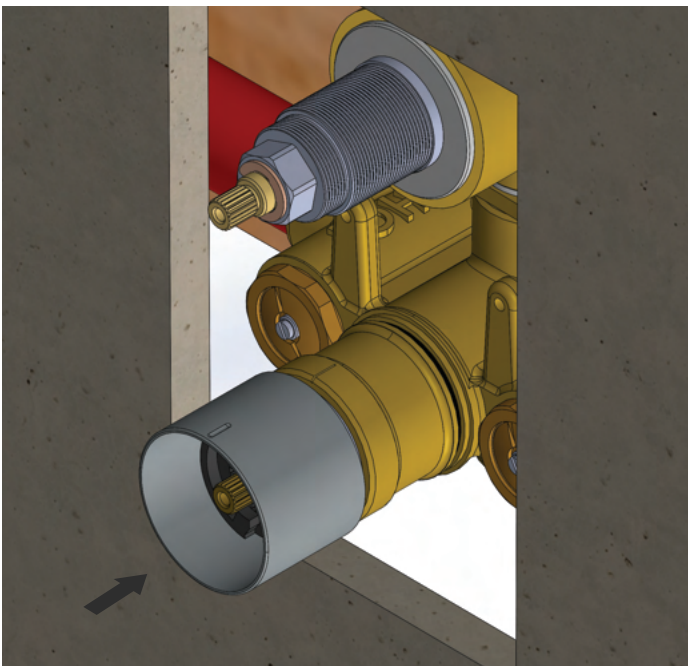

A hard push may be required

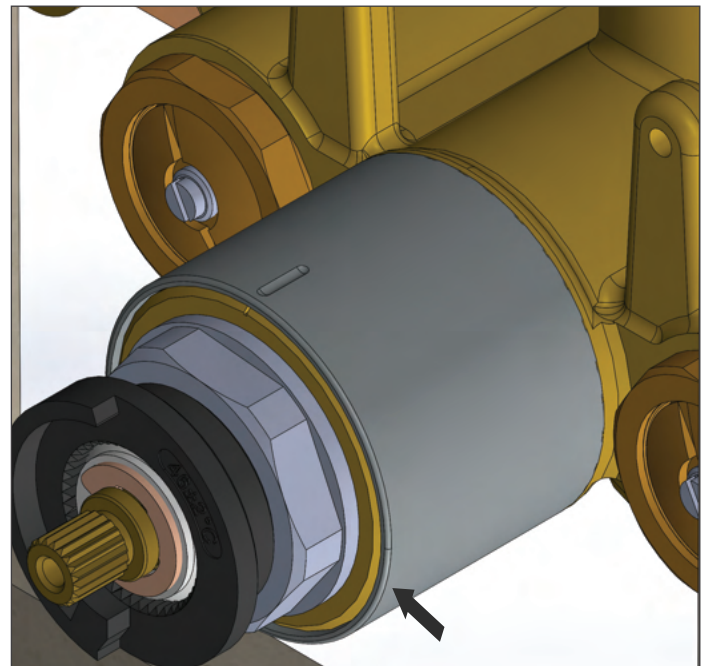

The 42mm ring must be flush. Otherwise the handle will not fit properly

INSTALLING THE TRIM - TRIM PLATE SIZE AND SHAPE MAY VARY - ILLUSTRATION ONLY

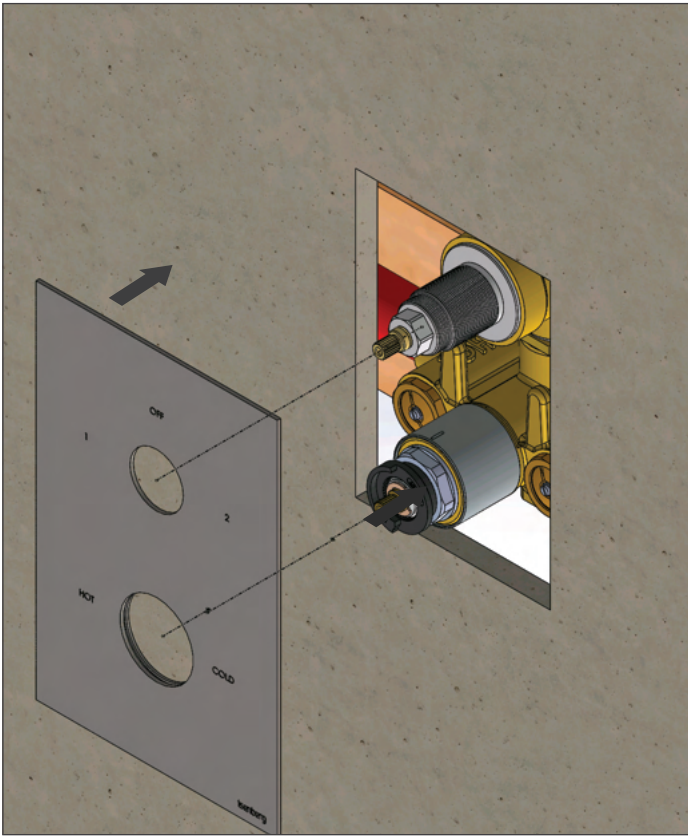

Insert trim plate

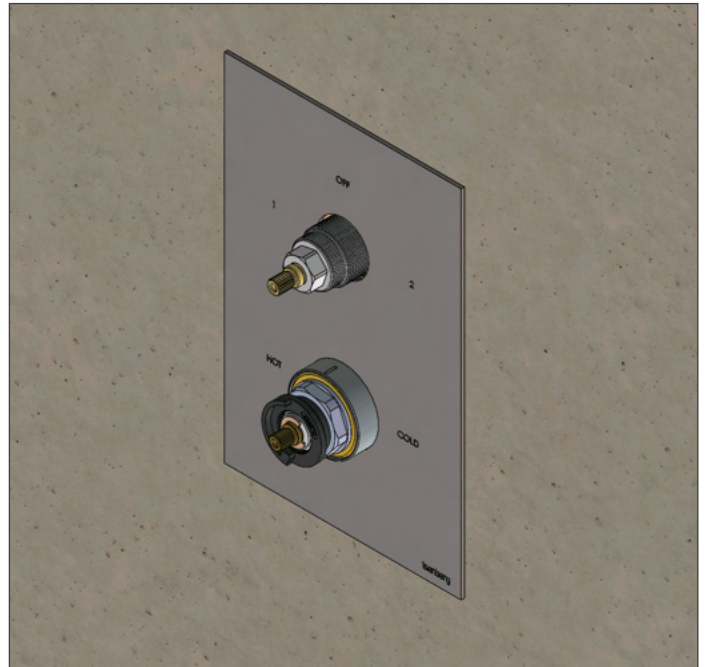

Align Trim plate till it is straight

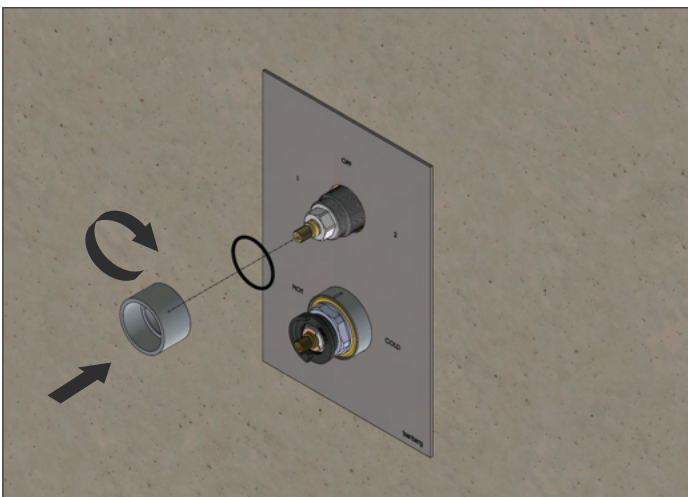

Insert adaptor base and tighten

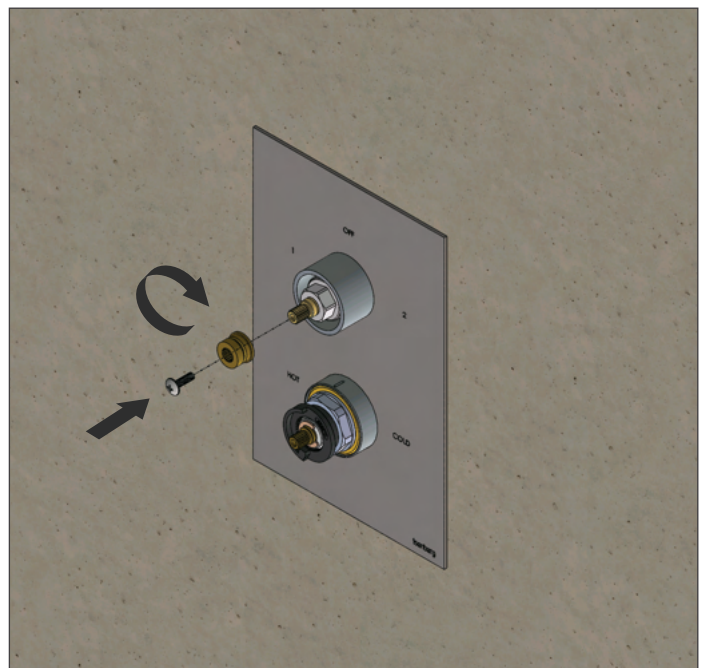

Insert centering knob & screws

INSTALLING THE TRIM - TRIM PLATE SIZE AND SHAPE MAY VARY - ILLUSTRATION ONLY

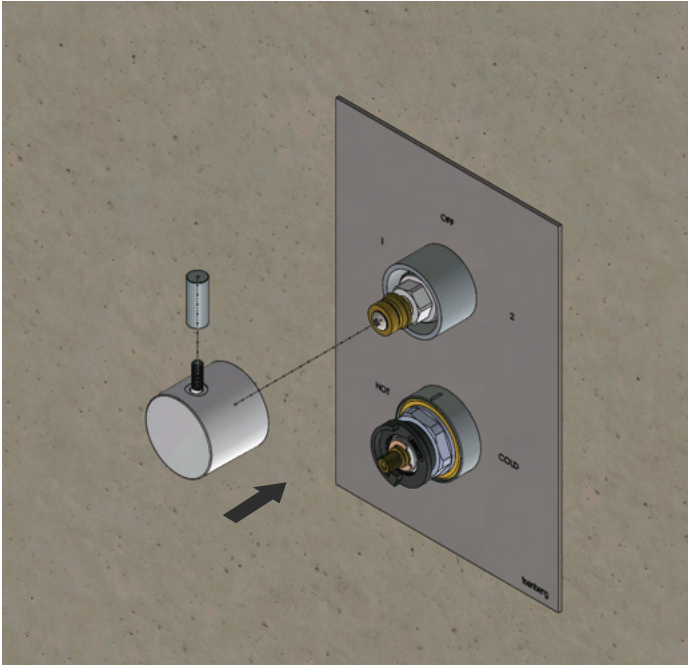

Insert diverter handle. Tighten hex screw & insert cover button. Make sure the diverter is set to the "OFF" marking before you begin

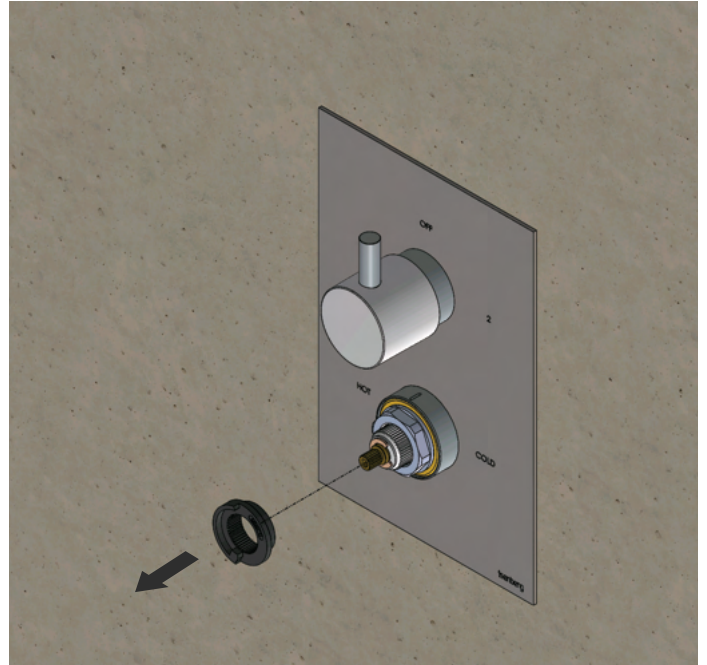

Remove anti-scald temperature ring

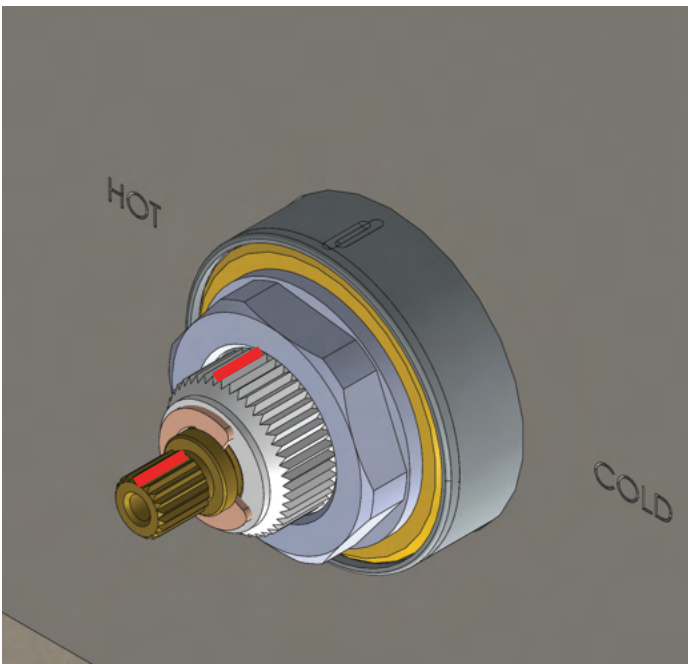

Caliberate cartridge before inserting temperature handle. Red marks must align.

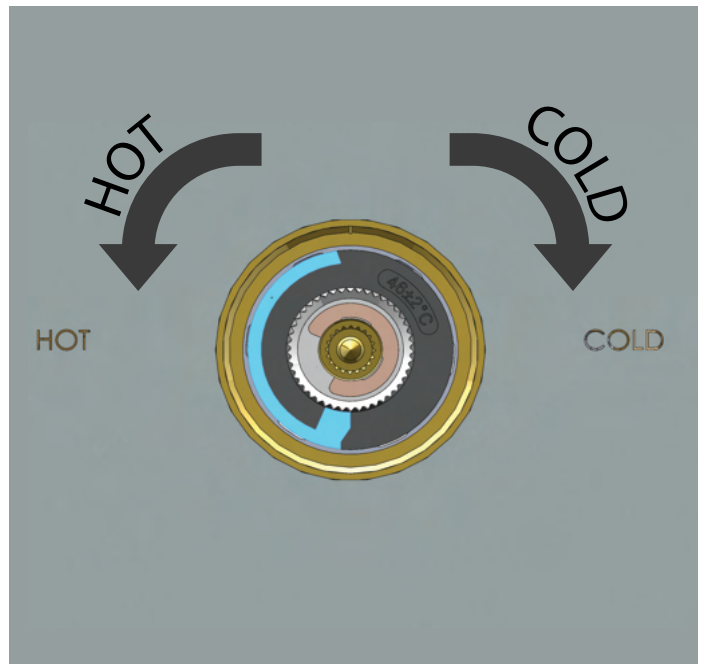

Correctly re-insert anti-scald temperature ring in the right position. To decrease maximum temperature, remove handle and rotate the anti-scald ring clockwise. To increase maximum temperature rotate the anti - scald ring counter-clockwise.

INSTALLING THE TRIM - TRIM PLATE SIZE AND SHAPE MAY VARY - ILLUSTRATION ONLY

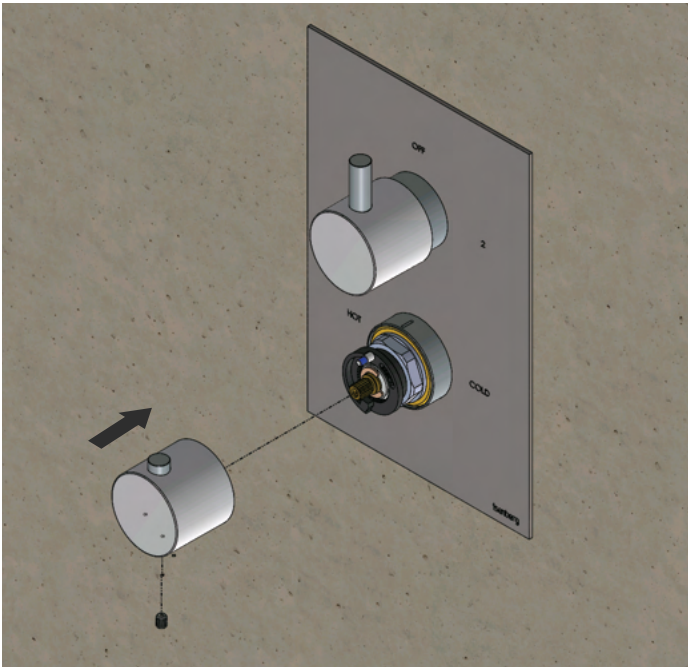

Insert temperature handle. Tighten hex screw & insert cover button

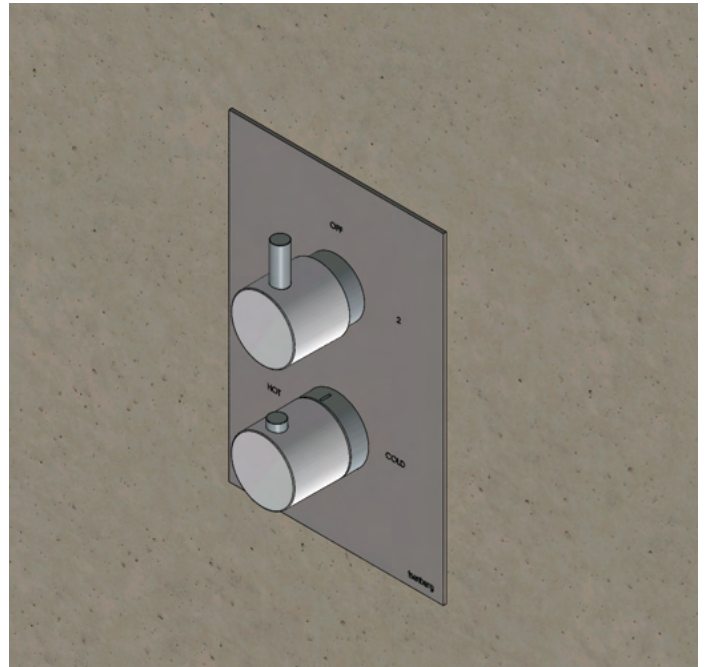

This photo shows a completely installed trim

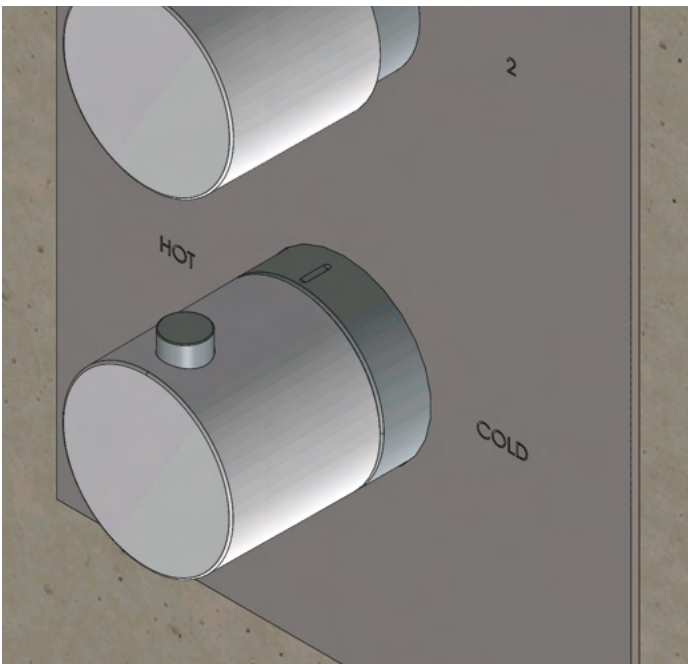

The button on the temperature handle is an anti scald feature. In order to rotate the handle further to "HOT" the button must be pressed